



WBSSETCL

WEST BENGAL STATE ELECTRICITY TRANSMISSION COMPANY LIMITED

SINGLE LINE DIAGRAM OF CK ROAD 132 KV SUB-STATION

132 KV TRNSFER BUS SINGLE
PANTHER ACSR (50 Hz, 3φ)

132 KV MAIN BUS, SINGLE
MOOSE ACSR (50 Hz, 3φ)

132 KV JACK BUS, SINGLE ACSR
PANTHER , (50 HZ, 3φ)

33 KV MAIN BUS-II
1.5" ALL. PIPE
(50 HZ, 3φ)

33 KV TRANSFER
BUS (50 HZ, 3φ)

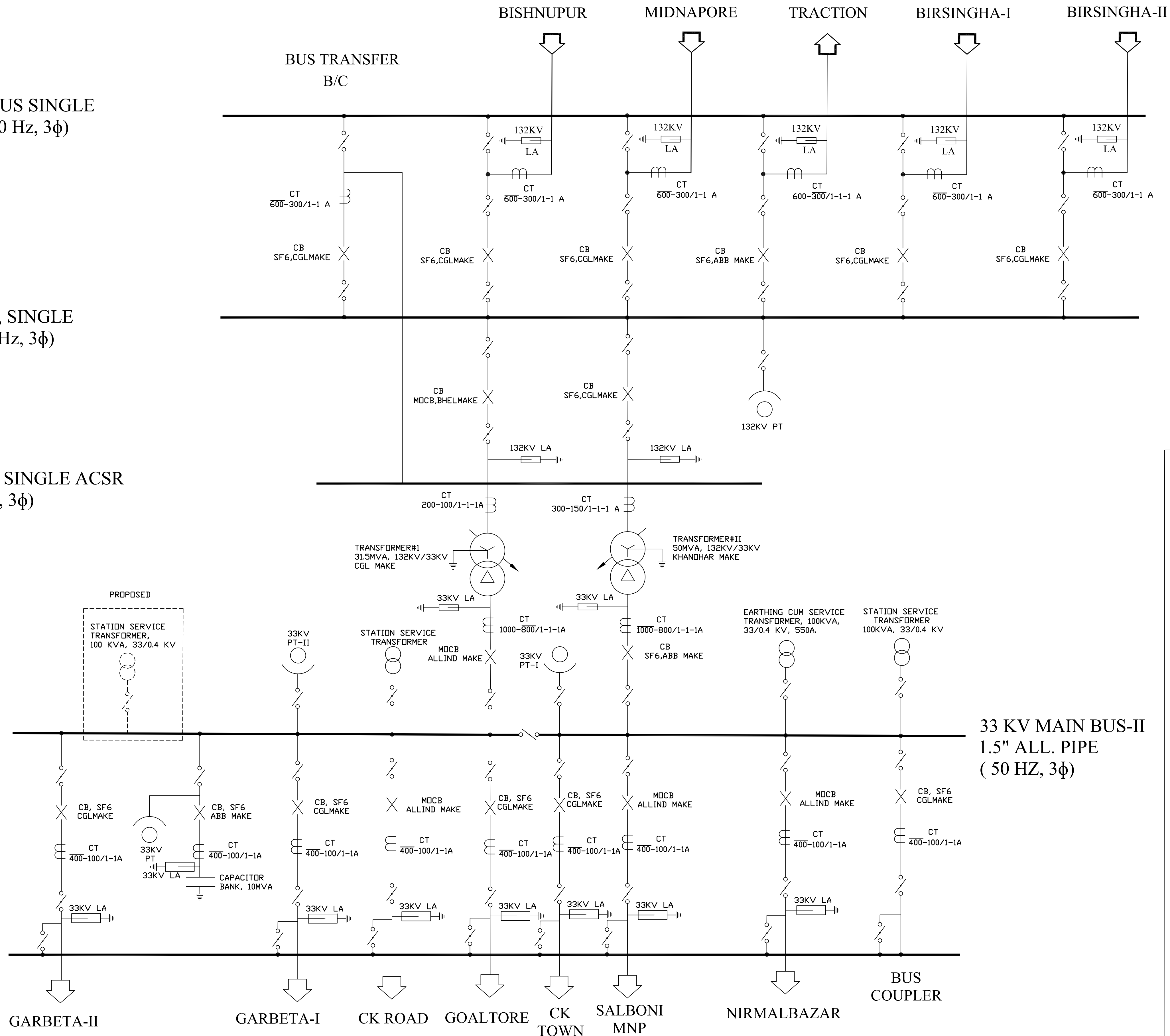

LEGENDS

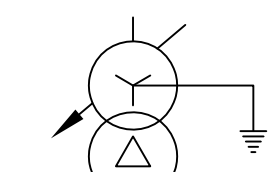
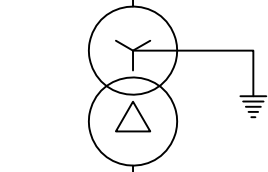
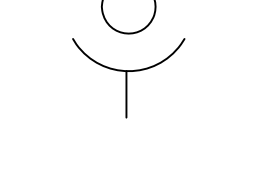
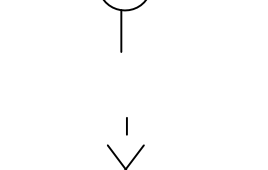
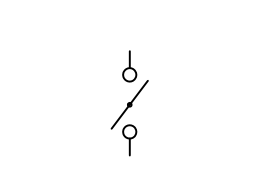
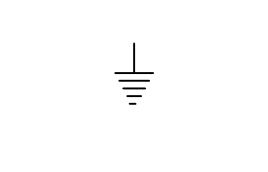
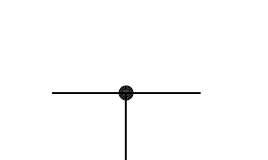
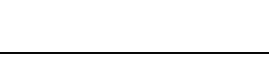
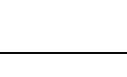
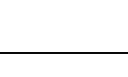
-  POWER TRANSFORMER (WITH OLTC)
-  POWER TRANSFORMER
-  POTENTIAL TRANSFORMER
-  STATION SERVICE TRANSFORMER
-  CIRCUIT BREAKER
-  ISOLATOR (DBCR)
-  LIGHTNING ARRESTER
-  EARTH
-  CURRENT TRANSFORMER
-  CONNECTED