

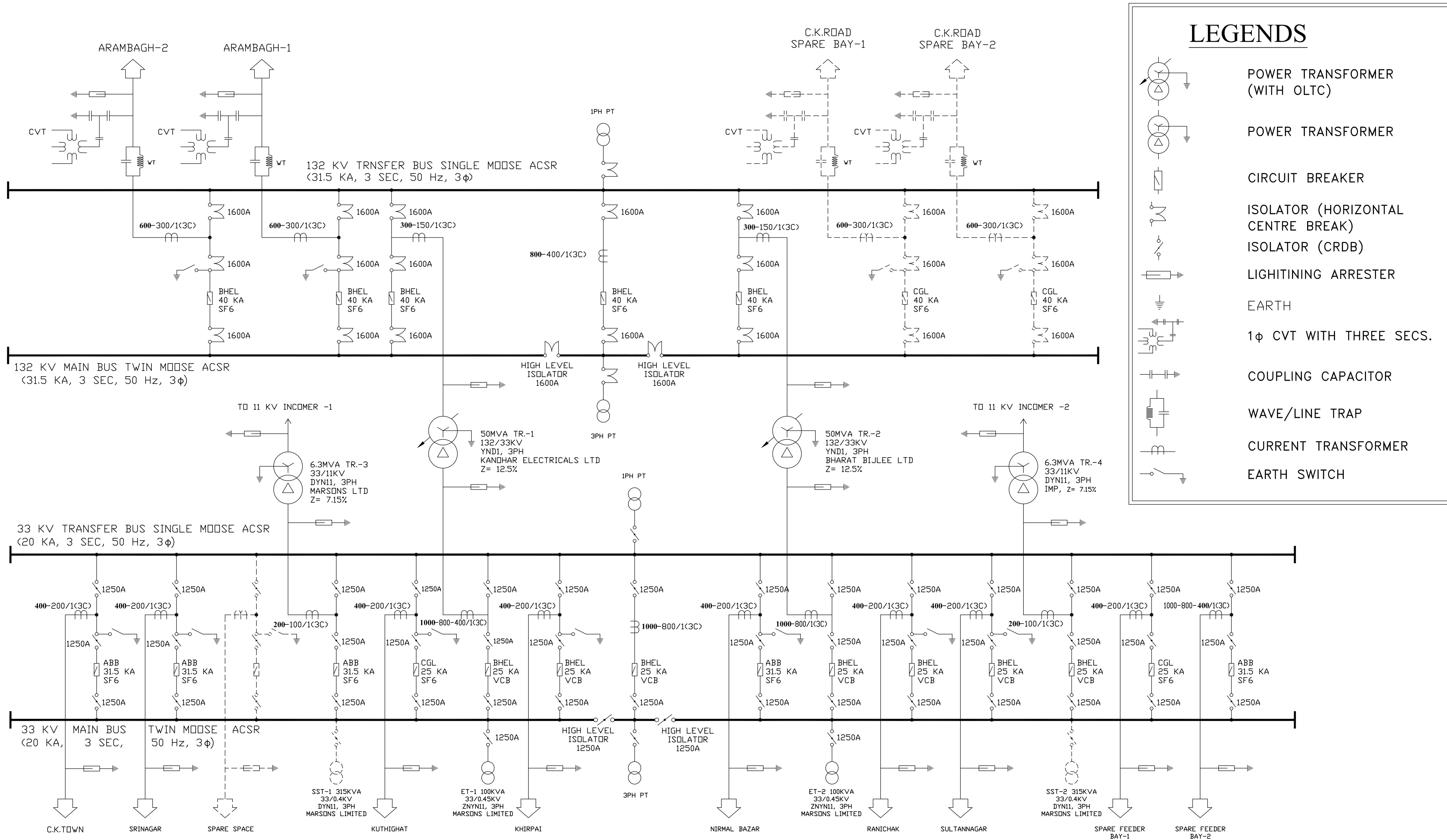

WEST BENGAL STATE ELECTRICITY TRANSMISSION COMPANY LIMITED

SINGLE LINE DIAGRAM OF BIRSINGHA 132 KV SUB-STATION

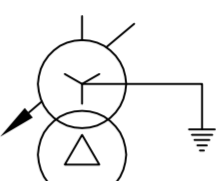
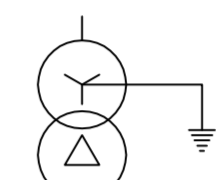
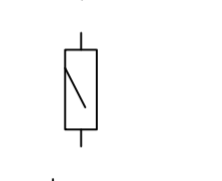
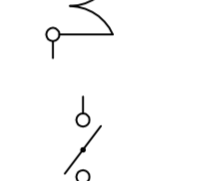
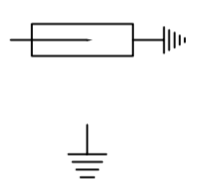
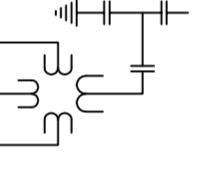
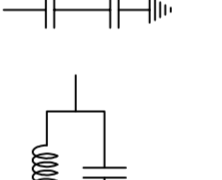
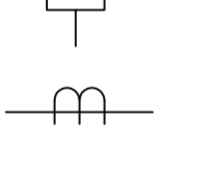

LEGENDS

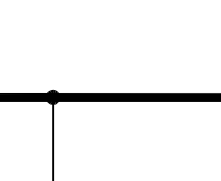
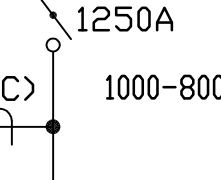
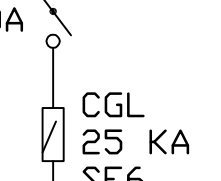
-  POWER TRANSFORMER (WITH OLTC)
-  POWER TRANSFORMER
-  CIRCUIT BREAKER
-  ISOLATOR (HORIZONTAL CENTRE BREAK)
-  ISOLATOR (CRDB)
-  LIGHTNING ARRESTER
-  EARTH
-  1φ CVT WITH THREE SECS.
-  COUPLING CAPACITOR
-  WAVE/LINE TRAP
-  CURRENT TRANSFORMER
-  EARTH SWITCH